

# FUMEX

# PR



## ***The ideal extractor for industrial environments.***

New technology in combination with new materials and a focus on design gives Fumex PR many new and important advantages:

- Unique ease of manoeuvrability.
- High positional stability.
- Hood designed for maximum capture efficiency and extraction.

PR's design is based on FUMEX's basic principles:

- External arm support.
- Hose dimensions according to requirement: 100, 125 or 160 mm.
- Hose quality according to application.
- Supplied partially assembled for ease of installation.

PR can be equipped with LED lighting and/or switch to control fan/damper.

FUMEX PR is available in the lengths 1.5, 2, 3, 4, 5, 7, 9 and 11 m.

*The Fumex range also includes fans, accessories, automatic control gear and filters for local extraction*

---

**LOCAL EXTRACTORS**  
**Pure advantages**



## **External arm supports deliver numerous advantages**

An externally positioned arm support has many advantages compared to extractors that have the supporting part internally in the extraction duct.

- Making the necessary adjustment to the friction joints is very simple.
- Option of selecting the correct hose dimension, Fumex PR is available in dimensions 100, 125 and 160 mm.
- Light-weight construction with two gas springs balancing its own weight.
- In addition always has the lowest possible pressure drop.

## **Always choose low pressure drop**

Low pressure drop always saves energy. In addition, low pressure drop produces a lower sound level, reducing the risk of disruptive ventilation noise and can more easily be combined with other extractors in the same system.

### **Fumex PR with external arm supports and joints delivers flexibility and advantages.**

The external link joints enable hose dimensions of 100, 125, and 160, and also make adjustment of the joints simple and relatively clean.

Compared to extractors with internal link systems, the PR arm has approx. 50% lower pressure drop.

### **Extractors with link joints internally in the suction duct have limitations and disadvantages**

Their size restricts the link joint's hose dimensions to 160mm as the smallest possible selection, moreover, the location makes the necessary adjustment of the joints both difficult and often dirty.

There is up to double the pressure drop compared with Fumex PR.

**Fumex PR**

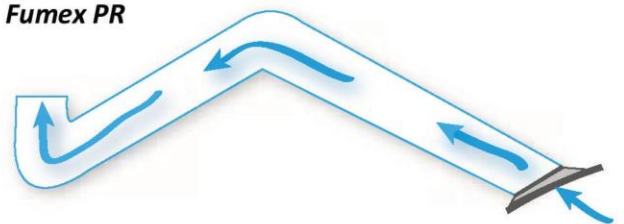

**Internal arm support**

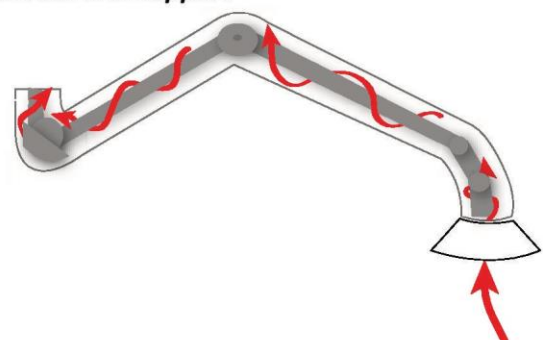

## A range of designs for different needs



### PR STANDARD

Brackets in powder coated steel. Arm supports in anodised aluminium and joints in anthracite grey PA & PP. Hood designed in accordance with EU standard. Injection moulded in anthracite grey PP with hood plate in anodised aluminium. Hose of dark-blue PVC.



### PR WHITE

White brackets in powder coated steel. Arm supports in anodised aluminium and joints in white PA & PP. White dome with anthracite grey handle, injection moulded in PP with dome plate in anodised aluminium. Hose in white PVC.



### PR RF

White brackets in powder coated steel. Arm supports in anodised aluminium and joints in white PA & PP. White hood with anthracite grey handle in injection moulded PP, stainless hood plate and screws. Bracket element in contact with the evacuated air made of stainless material. Hose of white PE-coated polyamide fabric. Used for evacuating corrosive gases.



The PR arm is also available in an ATEX version, see separate product sheet.

## Flow & Pressure Drop Diagram

The black line indicates the pressure drop for the arm in the same position as in the sketch. Recommended transport velocity for welding fumes is 18m/s. (See blue lines for each dimension.)

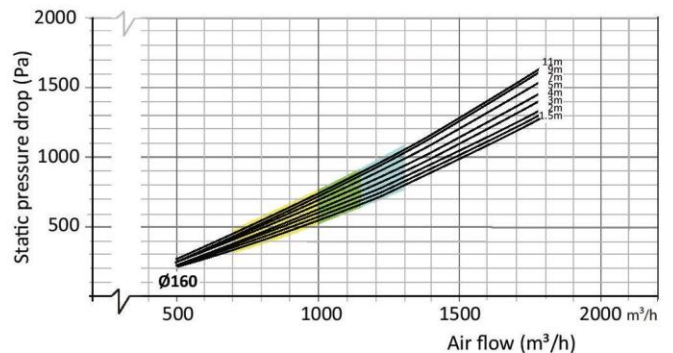
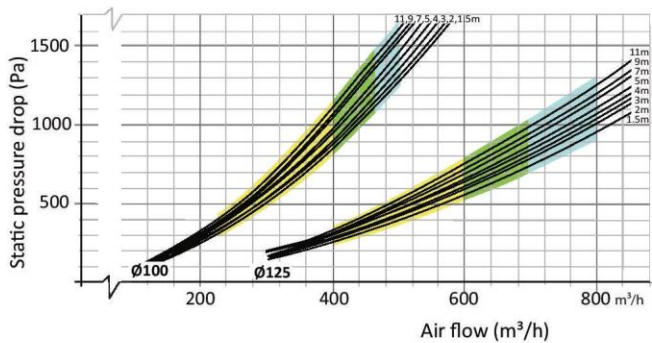

## Optimally designed hood



The hood is designed for maximum capture efficiency. It is ideal for capture of welding fumes and other hot contaminants. Capture efficiency for isothermal (non-hot) contaminants can be further improved by using the Coanda effect, which means that the air stream follows a level, solid surface, e.g. a table or a bench, rather than flowing freely through the room.

**PR 1500,  
2000 & 3000**

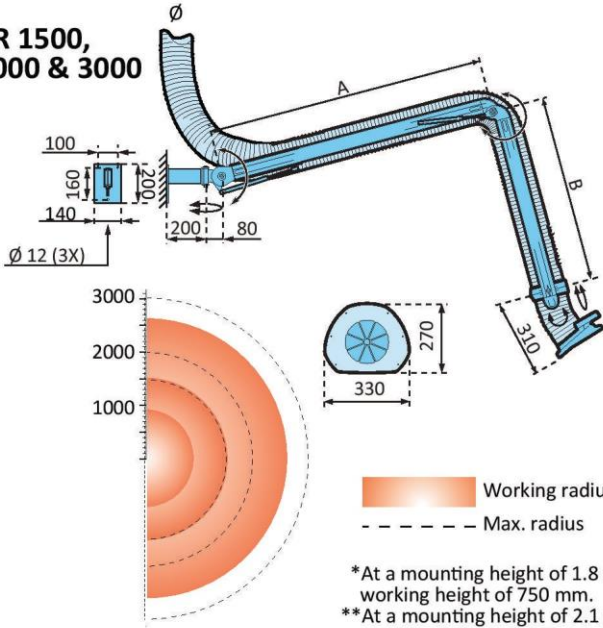

	A (mm)	B (mm)	Working radius* (mm)	Max. radius (mm)
PR 1500	420	490	910*	1500
PR 2000	950	490	1440**	2030
PR 3000	1450	990	2690**	3030

\*At a mounting height of 1.8 m and a working height of 750 mm.  
\*\*At a mounting height of 2.1 m and a working height of 750 mm.

**PR 4000**

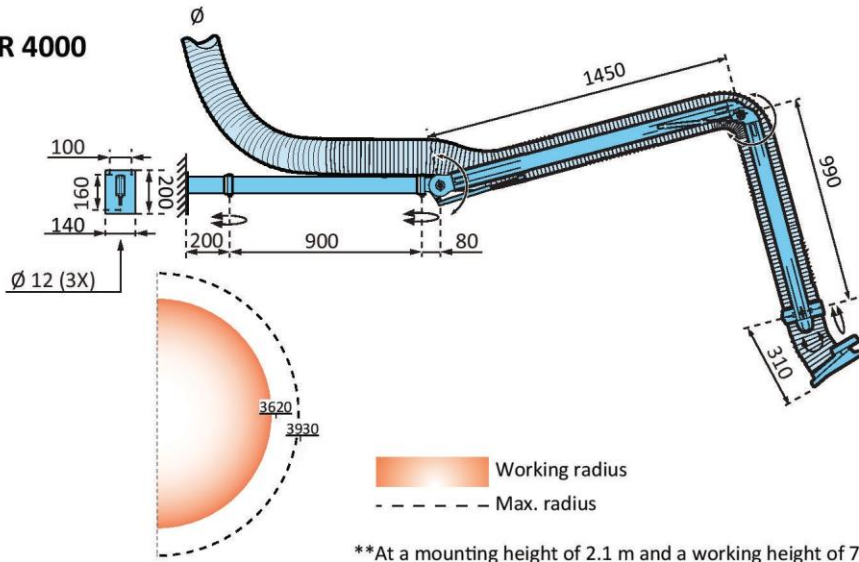

\*\*At a mounting height of 2.1 m and a working height of 750 mm.

**PR 5000**

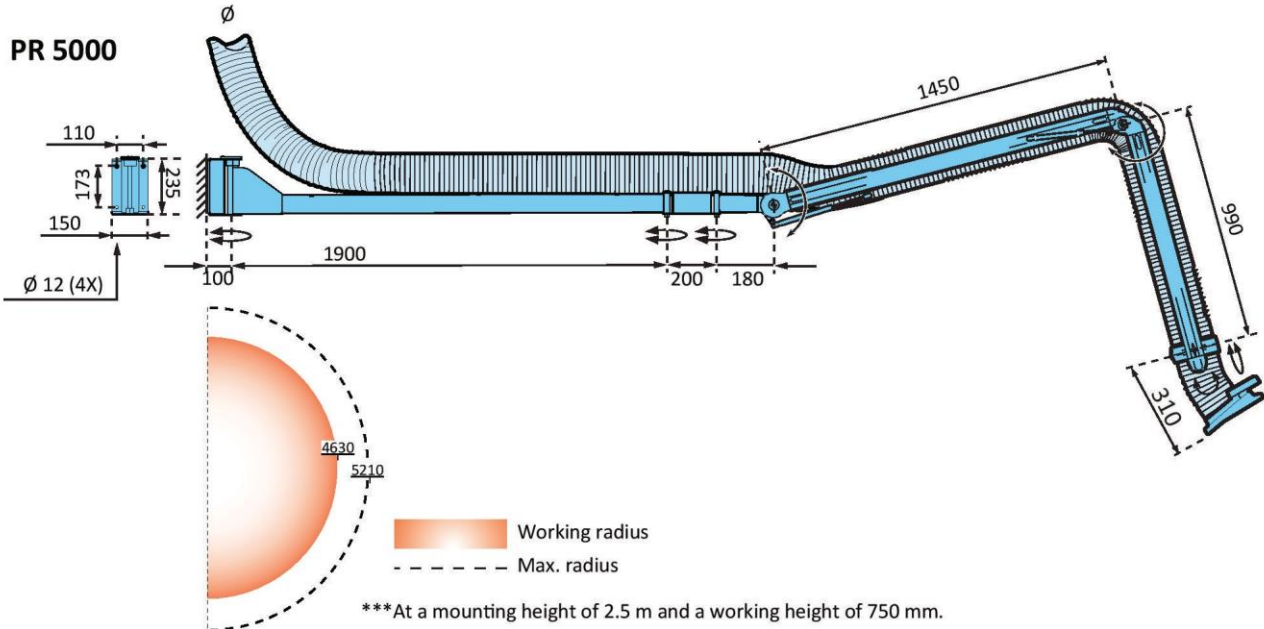

\*\*\*At a mounting height of 2.5 m and a working height of 750 mm.

**PR 7000**

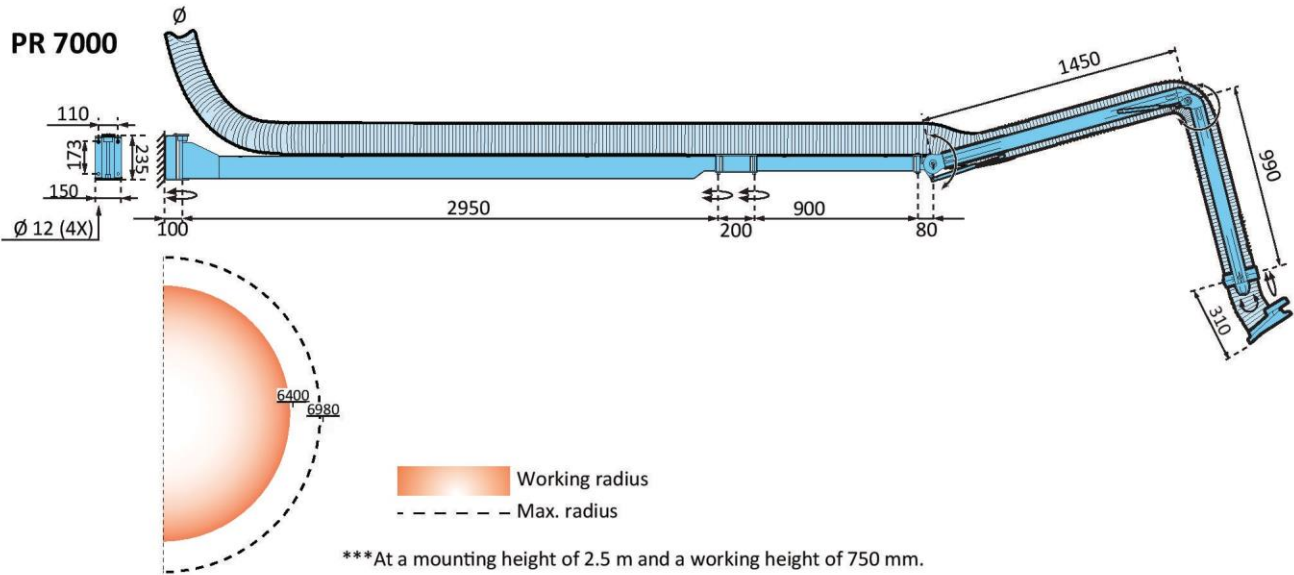

**PR 9000**

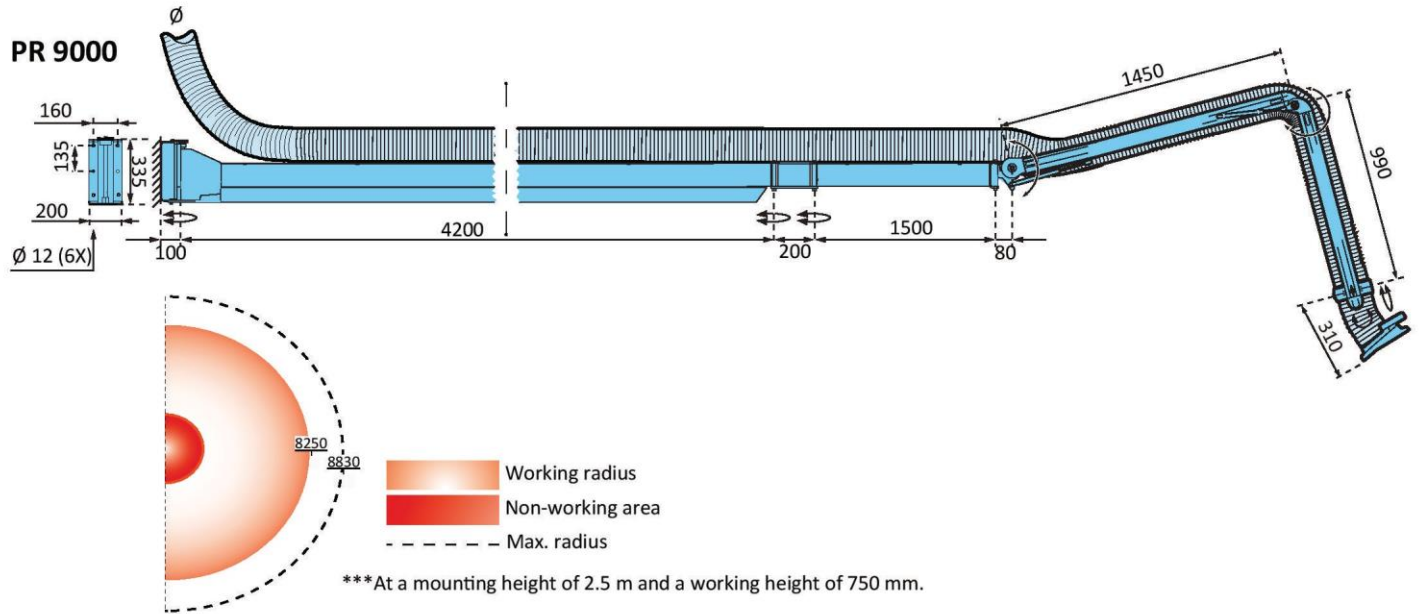

**PR 11000**

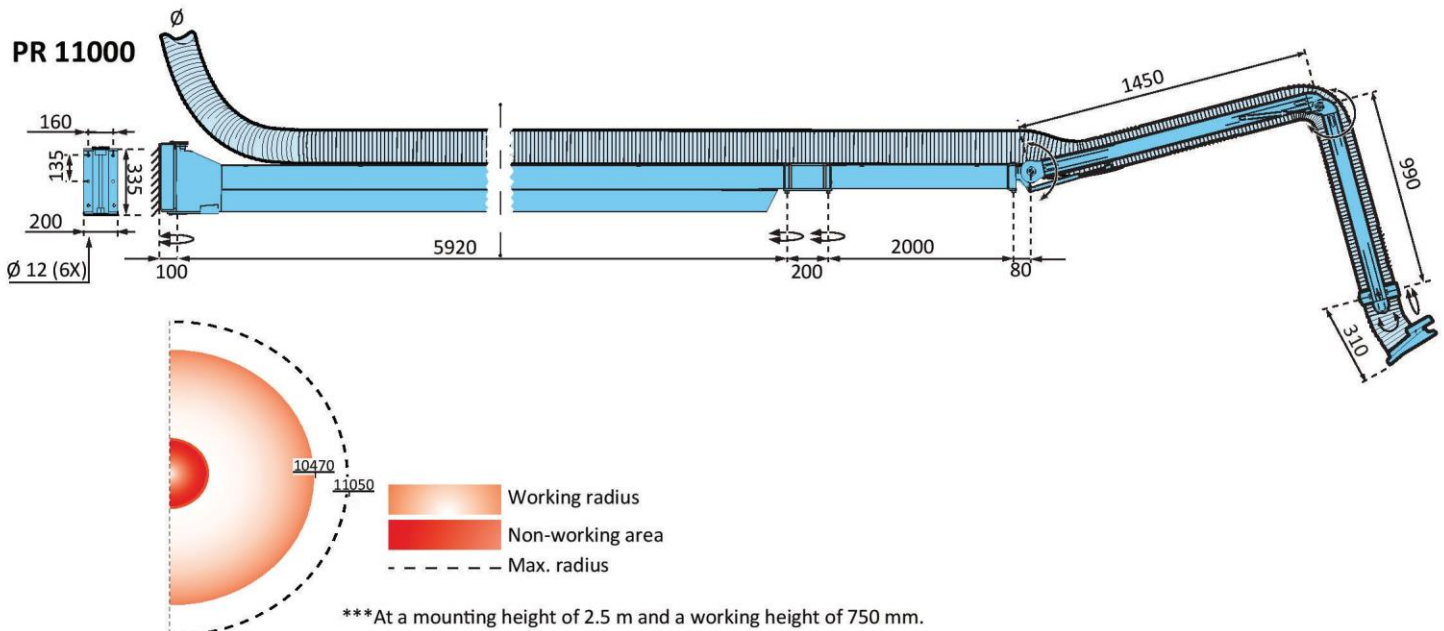

## Accessories

### Brackets for ceiling and floor mounting.

Fumex PR is supplied as standard including wall bracket. The following brackets are available for ceiling- and floor mounting.

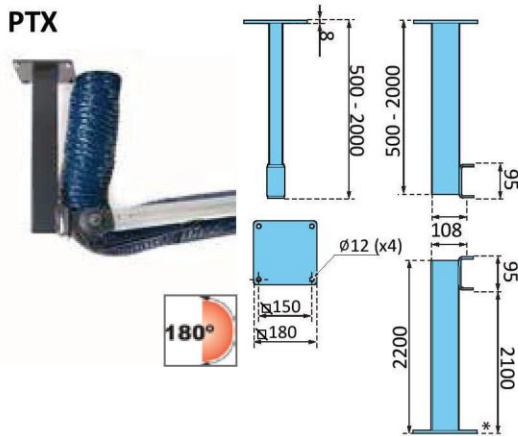

Ceiling- and floor bracket for extractor type Fumex PR in lengths 1.5, 2, 3 & 4m. Rotatable 180°.

PTX Article	Length (mm)	Weight (kg)
PTX 500	500	5
PTX 1000	1000	7,5
PTX 1500	1500	10
PTX 2000	2000	12,7
PTX 2200*	2200	14

\*Floor bracket

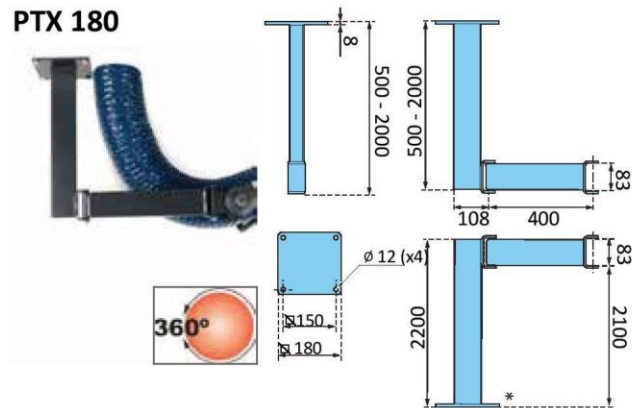

Ceiling- and floor bracket for extractor type Fumex PR in lengths 1.5, 2, 3 & 4m. Rotatable 360°.

PTX 180 Article	Length (mm)	Weight (kg)
PTX 180 500	500	6,7
PTX 180 1000	1000	9,3
PTX 180 1500	1500	12
PTX 180 2000	2000	14,5
PTX 180 2200*	2200	15,5

\*Floor bracket

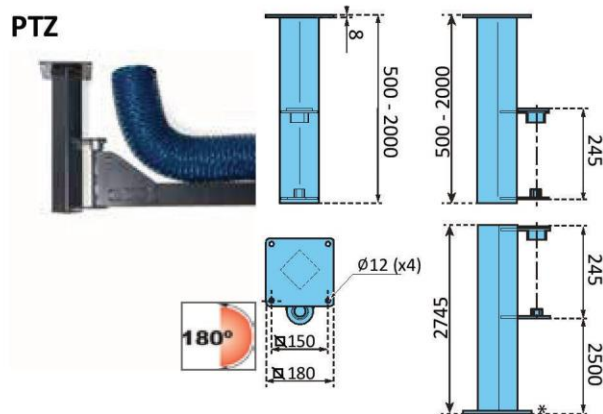

Ceiling- and floor bracket for extractor type Fumex PR in lengths 5 and 7m. Rotatable 180°.

PTZ Article	Length (mm)	Weight (kg)
PTZ 500	500	7,6
PTZ 1000	1000	12
PTZ 1500	1500	16,6
PTZ 2000	2000	21,2
PTZ 2500*	2745	25,7

\*Floor bracket

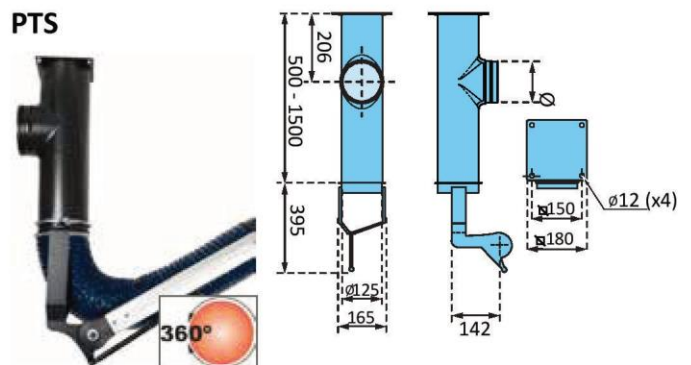

Ceiling bracket for extractor type Fumex PR in lengths 1.5, 2 and 3m. Rotatable 360°, Ø125 and Ø160mm.

PTS Article	Length (mm)	Ø (mm)	C (mm)	Weight (kg)
PTS 500-125	500	Ø125	300	6,6
PTS 1000-125	1000	Ø125	300	8,1
PTS 1500-125	1500	Ø125	300	9,6
PTS 500-160	500	Ø160	320	7,8
PTS 1000-160	1000	Ø160	320	9,7
PTS 1500-160	1500	Ø160	320	11,7

# FUMEX PR

## Accessories

### Work lighting and fan control.

Fumex PR can be supplied with work lighting and a push button for fan and damper control.



**PR LED**

LED work lighting including cabling, transformer and push button.



**PR T**

Push button for control of fan or damper.



**PR LED/T**

LED work lighting including cabling and transformer with push button and an additional push button for control of fan/damper.

### Technical data - lighting

Output ..... 5 W at 350 mA  
 Illuminance ..... 2000 lx  
 Colour temperature ..... 6500 K

## Friction brake

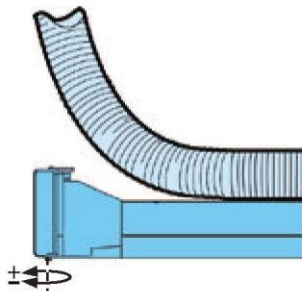

A friction brake can be mounted on the longer arms 5, 7, 9 and 11m. The brake is mounted under the wall bracket's joint, giving the arm optimum manoeuvrability and ensuring that the arm stays in the position selected.

The friction brake is included as standard in PR 9000 and PR 11000 and can be ordered as an accessory for PR 5000 and PR 7000.

Article	Description	Length (mm)	Weight (kg)
PR 100-6340	Friction brake	212	0.3

## Extension hose

With magnetic nozzle and quick connection adapted to the PR arm.

Hose, PVC coated polyamide fabric with fully embedded spring steel coil,  
 Temperature range -10° to +90°C  
 Plastic components PA, PA 30%  
 Aluminium components Anodised  
 Steel components Black oxidised, chromed or powder coated

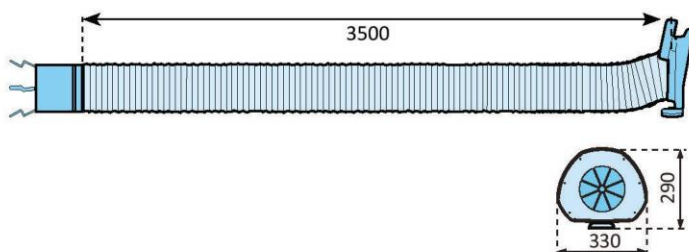

Article	Description	Ø	Length (mm)	Weight (kg)
PFS -125/4	Extension hose	Ø125	4000	4
PFS -125/8	Extension hose	Ø125	8000	6
PFS -160/4	Extension hose	Ø160	4000	4
PFS -160/8	Extension hose	Ø160	8000	6



### **Hose standard**

PVC coated polyamide fabric with fully embedded spring steel coil.  
Hose in quality that cope with aggressive chemicals and other hoses with special requirements can be supplied on request, contact Fumex.

### **Delivery configuration**

The arms are supplied partially assembled, including wall bracket, for ease of installation.

### **Technical data hose**

Properties ..... Non-inflammable, suitable for welding fumes and flue gases.  
Temperature range ..... -10°C to +90° C.

### **Technical data other standards**

Plastic components ..... PA, PA30%.  
Aluminium components ..... Anodised.  
Steel components ..... Black oxidised, chromed or powder coated.  
Weight ..... PR 1500: 9 kg PR 2000: 10 kg  
PR 3000: 12 kg PR 4000: 15 kg  
PR 5000: 23 kg PR 7000: 37 kg  
PR 9000: 52 kg PR 11000: 64 kg

 The PR arm is also available in an ATEX version, see separate product sheet.

# **KLEPP**

Aktiv durch saubere Arbeitsluft

Tel: 08061 9393 300 - Fax: 08061 9393 314  
E-Mail: [office@klepp.de](mailto:office@klepp.de) - [www.klepp.de](http://www.klepp.de)