

FUMEX ME 75



The ideal extractor for laboratory environments.

With its optimal design, the \varnothing 75 mm FUMEX ME has a very low pressure drop, which provides many valuable benefits.

- Low pressure drop saves energy.
- Air flow noise is reduced.
- Lower pressure drop is achieved without selecting a larger diameter extractor.
- Lower pressure drop allows the ME to be combined with additional extraction systems.

Unique design and stable mounting brackets make the Fumex ME your best choice.

Support for designing an efficient facility is available on page 5, and at www.fumex.com where you will find our design tool and CAD drawings.

The Fumex range also includes fans, accessories, automatic controls and filters suitable for local extraction.

LOCAL EXTRACTION
Pure advantages

FUMEX ME 75

Always choose a low pressure drop

Lowest possible pressure drop is a quality aspect that always should be considered.

With its uniquely designed joint construction, Fumex ME combines maximum flexibility with low pressure drop. The air passes through the joints without creating unnecessary turbulence, thus producing an energy-saving low pressure drop and a quieter working environment.



Recommended air flow

The recommended air flow for a $\varnothing 75$ arm is 120–150 m³/h. See table and diagram.

Activity	Air flow
Laboratories	120–150 m ³ /h 33–42 L/s
Schools – science classrooms	120–150 m ³ /h 33–42 L/s

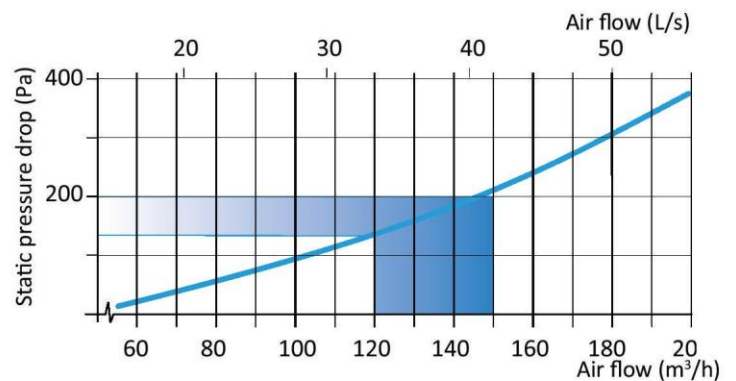

Static pressure drop is measured in accordance with ISO standard 5167-1.

Optimal capture

For optimum benefit from the local extractor, it is important to use the flexibility of the extractor to get as close to the contaminant as possible. A good rule of thumb would be a distance of 2–3 times the diameter of the extractor tube. At the recommended air flow, the extractor will provide high efficiency even if disturbances are generated in the surroundings.

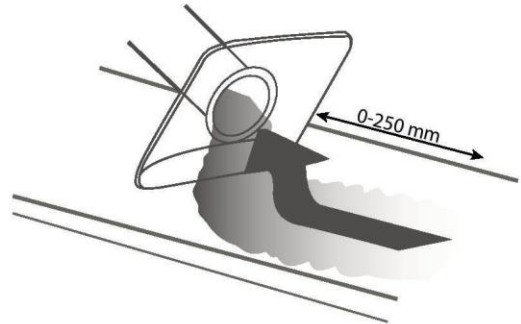

Unique benefits

The Fumex ME's joints have a patented friction design that, combined with the large joint diameter and single grip handle, provide a secure, position-stable arm with smooth adjustments. All without the need to apply excessive force or use tools on the adjusting knob.

Joints with reinforced ends and ball bearings moderate the friction and allow the arm to be moved up and down while maintaining stability and function.

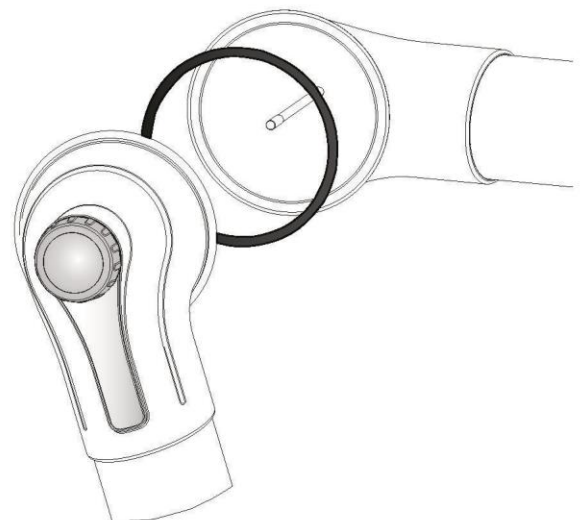

FUMEX ME 75

One arm. All options.

Fumex ME has a complete range of accessories to suit every situation, enabling you to create the optimal extractor for the evacuation of hazardous airborne gases and particulates.



PP version

Used primarily for evacuating very corrosive contaminants in high concentrations, e.g. in certain laboratories and in the pharmaceutical and chemical industries.



Standard version

Suitable for evacuating most types of airborne contaminants, e.g. in laboratories, schools, hospitals, the pharmaceutical industry, nail salons and light industrial applications.



ESD version



Suitable for evacuating airborne contaminants in environments where there is a need to avoid the risk of spark formation and in areas where products need to be ESD-certified, e.g. the electronics industry.



ATEX version



Suitable for evacuating airborne contaminants where there is a requirement for an ATEX-classified environment, e.g. in laboratories, the chemical and petrochemical industries, gas distribution, and the paint and pharmaceutical industries.



FUMEX ME 75

The MET with internal mechanical spring for ceiling and wall mounting

Standard	Size (mm)			Weight (kg)
	A	B	∅ C	
MET 1000-75	400	300	75	2,25
MET 1300-75	550	450	75	2,60
MET 1500-75	750	450	75	2,75
MET 2000-75	1000	650	75	3,25
PP	Size (mm)			Weight (kg)
A	B	∅ C		
MET 1000-75PP	400	300	75	2,25
MET 1300-75PP	550	450	75	2,60
MET 1500-75PP	750	450	75	2,75
ATEX	Size (mm)			Weight (kg)
A	B	∅ C		
MET 1000-75EX	400	300	75	2,25
MET 1300-75EX	550	450	75	2,60
MET 1500-75EX	750	450	75	2,75
ESD	Size (mm)			Weight (kg)
A	B	∅ C		
MET 1000-75ES	400	300	75	2,25
MET 1300-75ES	550	450	75	2,60
MET 1500-75ES	750	450	75	2,75

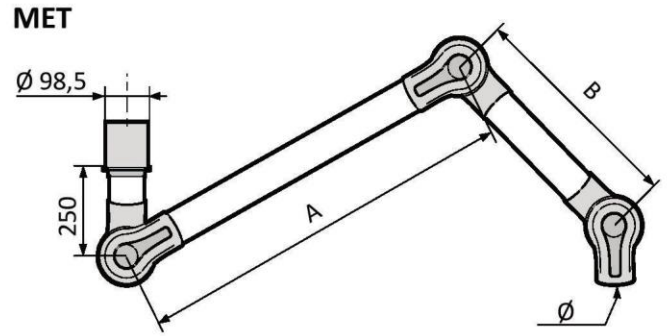

MET for ceiling or wall mounting, excluding bracket MTI or MVK.

The METS with external gas spring



For arms of length 1.5m and 2m, Fumex recommends the gas spring model to provide better stability.

The gas spring can also be used as a height stop, e.g. on low ceilings and where there are low electrical fittings.

Standard	Size (mm)			Weight (kg)
	A	B	∅ C	
METS 1500-75	750	450	75	2,75
METS 2000-75	1000	650	75	3,25
PP	Size (mm)			Weight (kg)
A	B	∅ C		
METS 1500-75PP	750	450	75	2,75
METS 2000-75PP	1000	650	75	3,25
ATEX	Size (mm)			Weight (kg)
A	B	∅ C		
METS 1500-75EX	750	450	75	2,75
METS 2000-75EX	1000	650	75	3,25
ESD	Size (mm)			Weight (kg)
A	B	∅ C		
METS 1500-75ES	750	450	75	2,75
METS 2000-75ES	1000	650	75	3,25

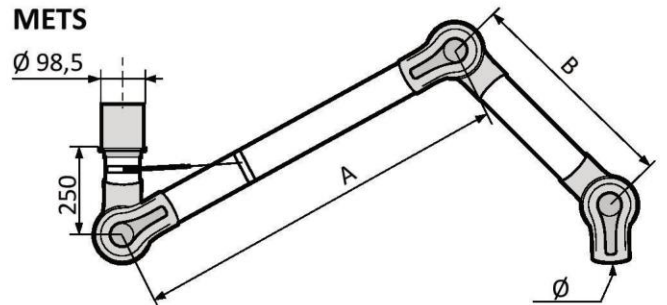

FUMEX ME 75

The MEB with internal mechanical spring for table mounting

Standard	Size (mm)			Weight (kg)
	A	B	∅ C	
MEB 1000-75	400	300	75	2,25
MEB 1300-75	550	450	75	2,60
MEB 1500-75	750	450	75	2,75

PP	Size (mm)			Weight (kg)
	A	B	∅ C	
MEB 1000-75PP	400	300	75	2,25
MEB 1300-75PP	550	450	75	2,60
MEB 1500-75PP	750	450	75	2,75

ATEX	Size (mm)			Weight (kg)
	A	B	∅ C	
MEB 1000-75EX	400	300	75	2,25
MEB 1300-75EX	550	450	75	2,60
MEB 1500-75EX	750	450	75	2,75

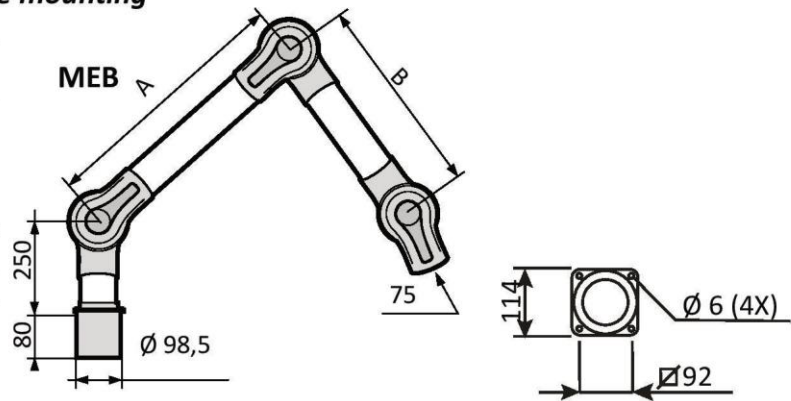

ESD	Mått (mm)			Vikt (kg)
	A	B	∅ C	
MEB 1000-75ES	400	300	75	2,25
MEB 1300-75ES	550	450	75	2,60
MEB 1500-75ES	750	450	75	2,75

Reach at recommended installation height

The following installation heights and sideways displacement relative to the work area are recommended for optimal extraction:

Recommended installation height

Designation	H (mm)
MET 1000-75	1700–2000
MET 1300-75	1900–2200
MET/S 1500-75	2000–2300
MET/S 2000-75	2200–2500

Recommended side displacement

radius, relative to work area

Designation	S (mm)
MET 1000-75	300–600
MET 1300-75	400–700
MET/S 1500-75	500–800
MET/S 2000-75	700–1000

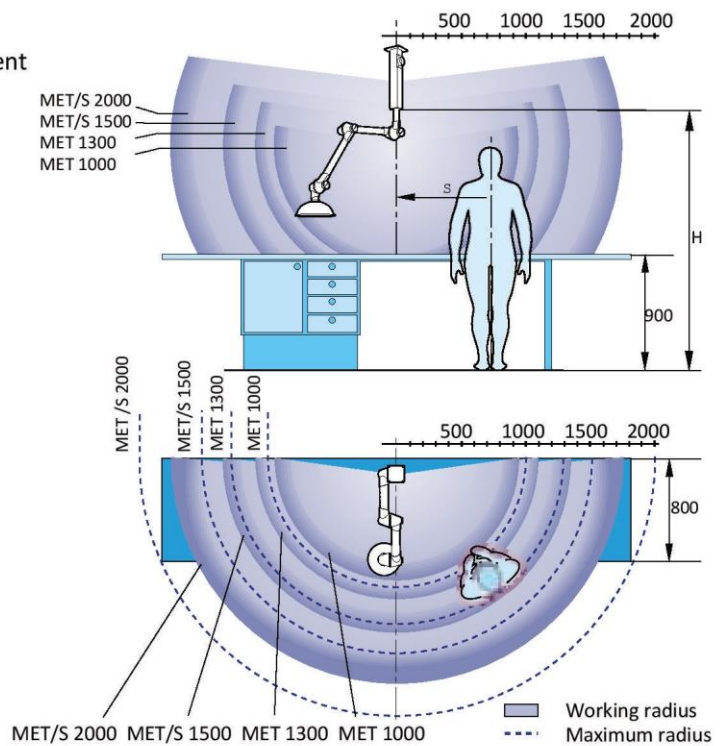

Pressure drop

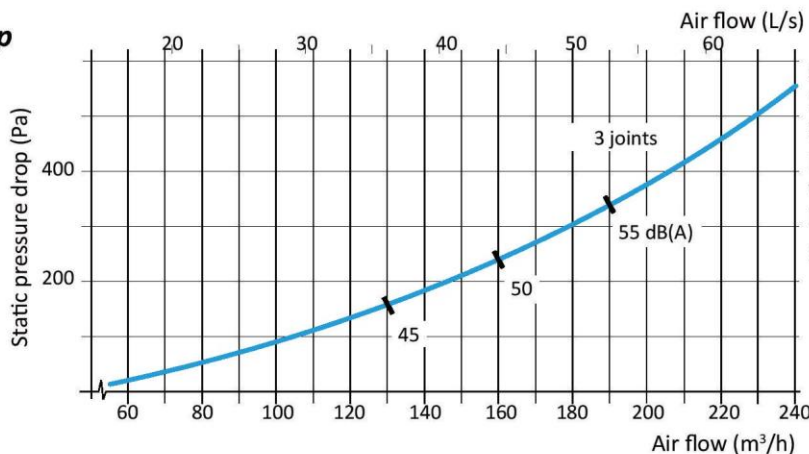

Static pressure drop is measured in accordance with ISO standard 5167-1.
Noise level is measured in accordance with ISO standard 3743.
Indicated sound level refers to sound pressure level.

FUMEX ME 75

Hoods

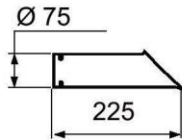

SUCTION NOZZLE

The suction nozzle is used in tight spaces and for getting close to the work without interfering.

Temp. range: -15°C to +80°C

Standard	Variants	Weight (g)
MES 300-75	PP,ES,EX	160

Material
Standard: Aluminium
PP Polypropylene
ES, EX PEEL black

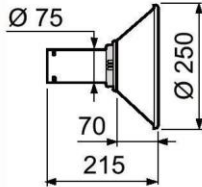

METAL HOOD

The metal hood is used when working in corrosive environments and for capturing hot gasses and dust splatter.

Metal hoods can be fitted with work lighting.

Temp. range: -15°C to +80°C

Standard	Variants	Weight (g)
MEM 250-75	PP,ES,EX	300

Material
Standard/PP: Powder-coated aluminium
ES Aluminium
EX Powder-coated aluminium

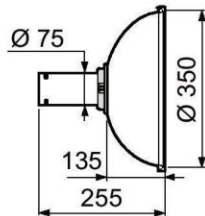

DOME HOOD

The clear dome hood is suitable for lighter gasses with a wider dispersal of contaminants without blocking the user's vision.

Temp. range: -15°C to +80°C

Standard	Variants	Weight (g)
MEK 350-75	PP,ES,EX	450

Material
Standard: PMMA
PP Polypropylene, transparent
ES, EX PEEL black

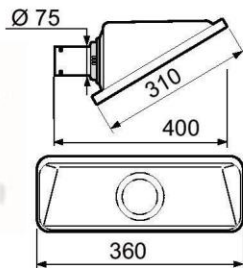

SQUARE HOOD

The square hood is suitable for placing above gasses with a high lift, or adjacent to the work surface for contaminants with no lift or low lift – all this without interfering with the work.

Temp. range: -15°C to +80°C

Standard	Variants	Weight (g)
MESH 350-75		485

Material
Standard: PETG

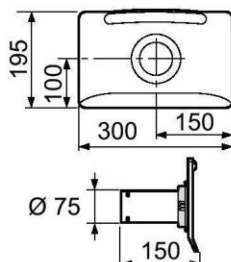

FLAT SCREEN HOOD

The flat screen hood is designed to maximise the working area without obscuring the object from the user. The flat screen hood gives the best suction effect for table and bench tasks.

Temp. range: -15°C to +80°C

Standard	Variants	Weight (g)
MEPH 300-75	PP,ES,EX	300

Material
Standard: PETG
PP Polypropylene
ES, EX PEEL black

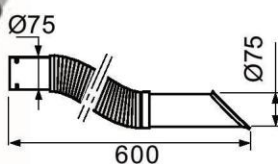

FLEXIBLE SUCTION NOZZLE

The flexible suction nozzle is designed to maximise ease of movement without sacrificing air flow efficiency. Available in the ESD version only.

Temp. range: -15°C to +80°C

Standard	Variants	Weight (g)
MEFS 600-75ES	-	425



PROTECTIVE GRILL

Protective grill to be monted in joints. Prevents objects being sucked into the system.

Temp. range: -15°C to +80°C

Standard	Variants	Weight (g)
MESG-75	ES,EX	7

FUMEX ME 75

Brackets



All Fumex laboratory extractors have as standard a full swivel that allows 360° of rotation without the need to add special sleeve couplings.

Both ceiling and wall brackets have a special square-shaped profile in anodised aluminium to provide a stylish and stable installation. This aluminium profile also allows both the wall and ceiling brackets to be custom tailored at the job site.

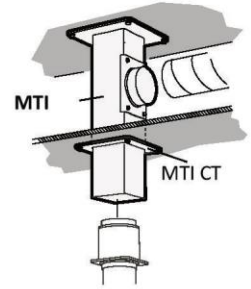

The MTI and MTF ceiling bracket

The ceiling bracket functions as a simple and stable duct for outgoing air, avoiding the need for expensive ducting and additional holes through false ceilings. On request, the MTI can be supplied in lengths exceeding 2 m.

	Dimensions (mm)	Weight (kg)
Standard	L	
MTI 250	250	3.15
MTI 500	500	3.80
MTI 750	750	4.50
MTI 1000	1000	5.15
MTI 1250	1250	5.80
MTI 1500	1500	6.45
MTI 1750	1750	7.10
MTI 2000	2000	7.75

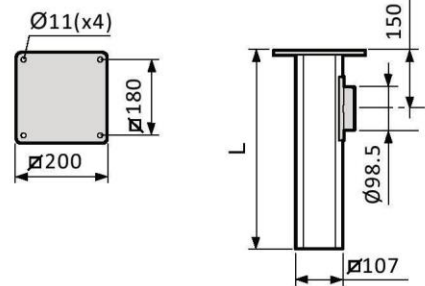
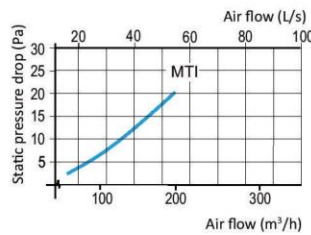

Ceiling bracket, for fitting through beams. The attachment plate is adjustable for the entire length of the aluminium profile. If required, the aluminium profile can be cut during fitting.

	Dimensions (mm)	Weight (kg)
Standard	L	
MTF	1000	4.20

As well as the standard design, the MTI/MTF is available in an ESD (ES) or ATEX (EX) version. The ceiling brackets can be supplied with an epoxy-coated exterior in all lengths up to 3 m (L).

For aggressive environments, we recommend epoxy coating on the interior and exterior up to 1.25 m (IL).

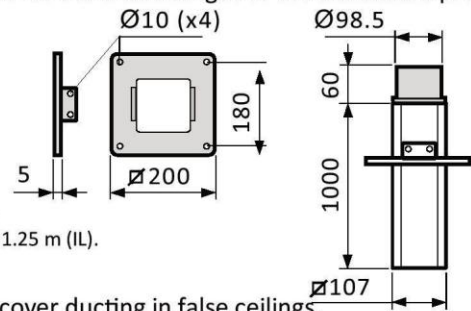

The MTI CT escutcheon plate

Escutcheon plate, used with the MTI ceiling bracket for stabilization and to cover ducting in false ceilings.

	Weight (kg)
Standard	
MTI CT	0.050

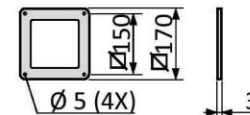

As well as the standard design, the escutcheon plate is available in an ESD (ES) or ATEX (EX) version.

MVK wall bracket

Included as standard for a wall-mounted arm.

Wall brackets can be special ordered in custom horizontal and vertical lengths.

	Weight (kg)
Standard	
MVK	2.15

As well as the standard design, the bracket is available in an ESD (ES) or ATEX (EX) version.

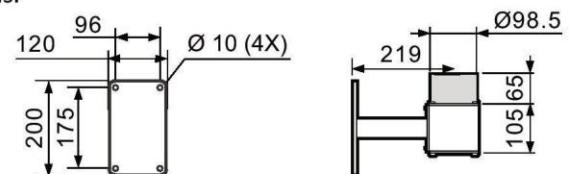

MBF flexible table bracket

Flexible bracket for attaching to a table-top or shelving. Supplied complete with two clamps.

	Weight (kg)
Standard	
MBF	0.75

As well as the standard design, the table bracket is available in an ESD (ES) version.

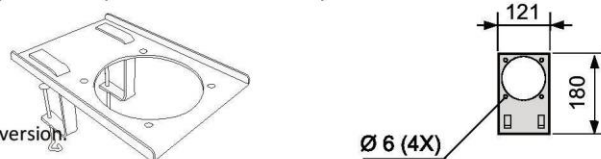

MRM reducing sleeve

Polypropylene, fits standard Ø 98.5 mm attachment, for reducing down to Ø 75.

	Weight (kg)
Standard	
MRM 100-75	0.08

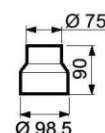



Material description

Friction joints

Ball bearing-equipped adjustable friction joints in polypropylene (PP), with guide ring in low friction-treated rubber. Support springs and other component parts in zinc-plated steel or stainless steel.

Tubes

Made from thin-walled anodised aluminium or from polypropylene. Air-tight damper supplied as standard.

ME Standard

The standard ME version has polypropylene joints and anodised aluminium tubes. The standard ME version is suitable for evacuating most types of airborne contaminants, e.g. in laboratories, schools, hospitals, the pharmaceutical industry, hairdressing salons and light industrial applications.

ME PP

Polypropylene joints and tube version. All metallic parts that are in contact with the air flow are made of stainless steel. The PP version of the ME is used primarily for evacuating very corrosive contaminants in high concentrations, e.g. in certain laboratories and in the pharmaceutical and chemical industries. When using a PP extractor fitted to a ceiling, we recommend that you order the MTI ceiling bracket with an internal epoxy coating.

ME ATEX



Conductive polypropylene joints and tubes. All metallic parts that are in contact with the air flow are made of stainless steel. Static electricity is diverted to a separate earth connection. All steel supporting parts are lined in a conductive powder coating. The product meets the requirements of category 2 of the ATEX directive (94/9/EC) for gases and dust.

The ATEX version of the ME is suitable for evacuating airborne contaminants where there is a requirement for ATEX-classified products, e.g. laboratories, the chemical and petrochemical industries, gas distribution, and the paint and pharmaceutical industries.

ME ESD



Joints and tubes are made from conductive polypropylene, making the entire arm electrically conductive and diverting any static electricity to a separate earth connection. The ESD version of the ME is suitable for the evacuation of airborne contaminants in environments where there is a need to avoid the risk of spark formation caused by static electricity and in areas where products need to be ESD-certified for use, e.g. the electronics industry. The ME ESD has been approved in accordance with EN 61340-5-1.

Delivery

Ceiling version MET	Supplied assembled, excluding hood or suction nozzle. The MTI or MTF ceiling brackets should be ordered separately.
Wall version MET	Supplied assembled, excluding hood or suction nozzle. MVK wall bracket should be ordered separately.
Table version MEB	Supplied assembled, with attachment plate for table fitting, excluding hood or suction nozzle. The MBF flexible table bracket should be ordered separately.



Aktiv durch saubere Arbeitsluft
Tel: 08061 9393 300 – Fax: 08061 9393 314
E-Mail: office@klepp.de – www.klepp.de